

KUHL[®]
— MESSER —



INDUSTRIAL BLADES
SANAYİ JİLETLERİ

Kühl Messer



www.kuhlmesser.com

INDUSTRIAL BLADES **SANAYİ JİLETLERİ**



www.kuhlmesser.com

Müşterilerimizin taleplerine göre özel bıçaklar üretilmektedir.

Special knives are produced according to the demands of our customers.

Katalogda yer alan ürün çeşitlerimizin haricinde farklı materyal, kaplama ve ölçüler mevcut olup, müşterilerimizin taleplerine göre stoklarımızdan temin edilmektedir.

Please be informed that besides our products mentioned here alternative materials, coatings and measurements are available from our company stock.

3 Delikli Oval ve Köşeli Jiletler / 3 Hole Blades

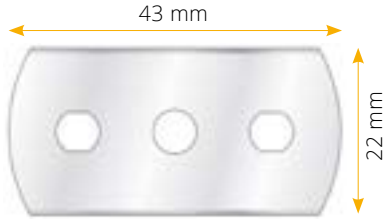

43 x 22 x Kalınlık / Thickness

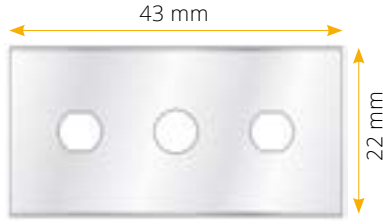

43 x 22 x Kalınlık / Thickness

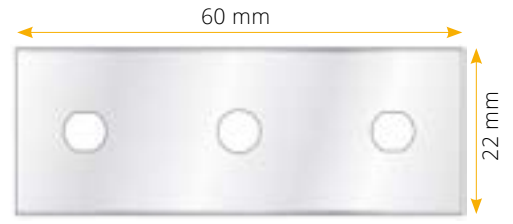

60 x 22 x Kalınlık / Thickness

Kalınlık / Thickness

0.10 - 0.13 - 0.15 - 0.20 - 0.30 mm
0.10 TİN - 0.15 TİN - 0.20 - 0.30 mm TİN
Tungsten / Carbide
Seramik / Full Ceramic

Kalınlık / Thickness

0.10 - 0.15 - 0.20 - 0.30 mm
0.10 TİN - 0.15 TİN - 0.20 - 0.30 TİN
mm
Tungsten / Carbide
Seramik / Full Ceramic

Kalınlık / Thickness

0.15 - 0.20 - 0.30 mm
0.15 TİN - 0.20 - 0.30 TİN mm
Tungsten / Carbide
Seramik / Full Ceramic

Slotlu Jiletler / Slotted Razor Blades

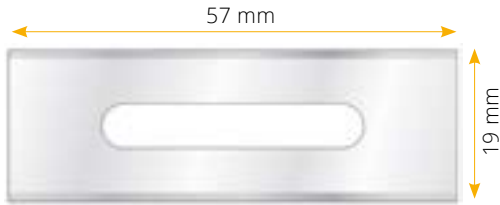

57 x 19 x 0.38 mm

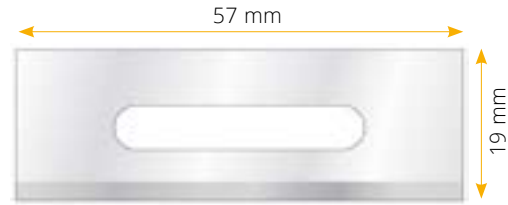

57 x 19 x 0.38 mm

Materyal / Material

Karbon Çelik / Carbon Steel
TİN Kaplama / TİN Coated
Çelik + Seramik Kaplama + Steel + Full Ceramic Coating
Tungsten / Carbide
Seramik / Full Ceramic

Kalınlık / Thickness

0.38 mm
0.38 mm
0.38 mm
0.38 mm
0.38 mm

Tek Kenarlı Jiletler

Single Edge Razor Blades

Kılıflı / With Spine

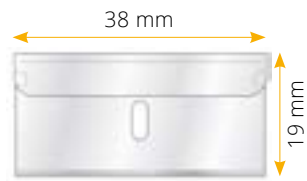

38x19x0.20 - 0.30 mm

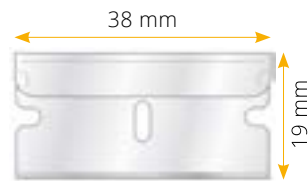

38x19 x 0.20 - 0.30 mm

Kılıfsız / Without Spine

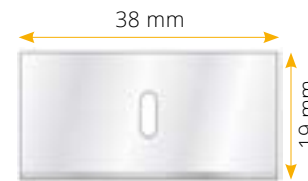

38x19 x 0.20 - 0.30 mm

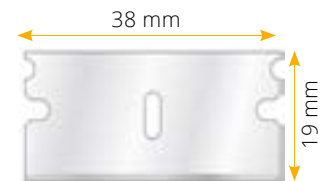

38x19 x 0.20 - 0.30 mm

İnjektör Jiletler

Injector Razor Blades

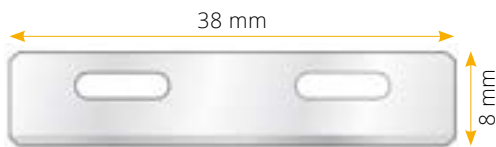

38 x 8 x 0.25 mm

Materyal / Material

Paslanmaz Çelik / Stainless Steel
Karbon Çelik / Carbon Steel
TİN Kaplama / TİN Coated
Çelik + Seramik Kaplama + Steel + Ceramic Coating
Tungsten / Carbide (Yuvasız / Without Slot)
Full Ceramic (Yuvasız / Without Slot)

Kalınlık / Thickness

0.25 mm
0.25 mm
0.25 mm
0.25 mm
0.25 mm
0.25 mm

Kanca Bıçaklar

Hook Blades

KUHL
MESSER



49 x 19 x 0.6 mm



49 x 19 x 0.6 mm



52x19x0.6 mm



52 x 19 x 0.6 mm



49 x 19 x 0.6 mm



49 x 19 x 0.6 mm



87 x 10 x 0.7 mm

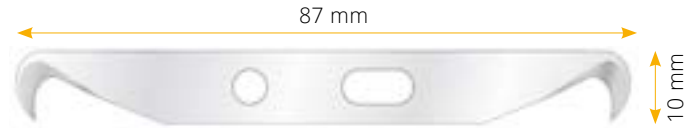

87 x 10 x 0.7 mm



59 x 19 x 0.6 mm



80 x 13 x 0.7 mm

İnce Bıçaklar

Slim Knife Blades



55.5 x 10.3 x 0.53 mm

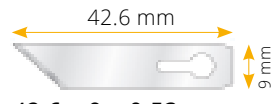

42.6 x 9 x 0.53 mm

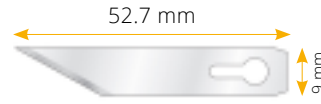

52.7 x 9 x 0.60 mm



50 x 9 x 0.60 mm

Lamel Yapraklı Bıçaklar

Lamel Blades

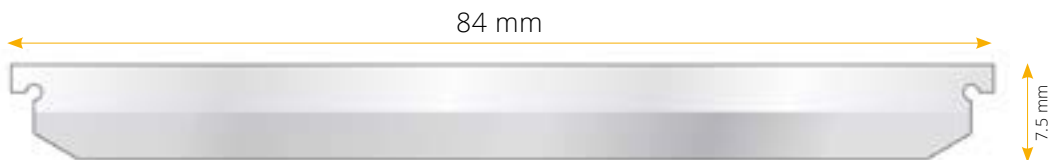

84 x 7.5 x 1 mm

Elmas ve Camelyafı Jiletler

Fiber and Fiberglass Chopper Blades

KUHL
MESSER

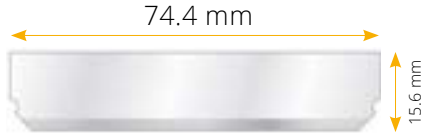

74.4 x 15.6 x 0.84 mm



117.6 x 15.6 x 0.84 mm

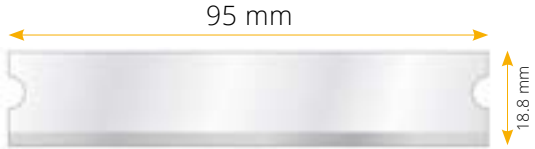

95 x 18.8 x 0.91 mm

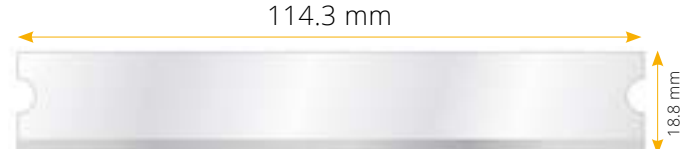

114.3 x 18.8 x 0.91 mm



Length x 8.00 x 0.30 mm



48 x 8 x 0.90 mm

Hobi Bıçakları

Hobby Knife Blades



55.5 x 8.4 x 0.53 mm



40 x 9 x 0.53 mm



37 x 10 x 0.53 mm



40 x 10 x 0.53 mm



45 x 13 x 0.63 mm
45 x 16 x 0.63 mm
45 x 20 x 0.63 mm



39 x 11.7 x 0.63 mm



45 x 10 x 0.60 mm

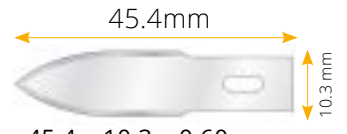

45.4 x 10.3 x 0.60 mm

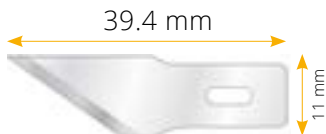

39.4 x 11 x 0.63 mm



47 x 11 x 0.63 mm



45 x 11 x 0.63 mm

Yüksek Zorluk Jiletleri / Heavy Duty Blades (0.64 mm)

Kısa Tip / Short Type

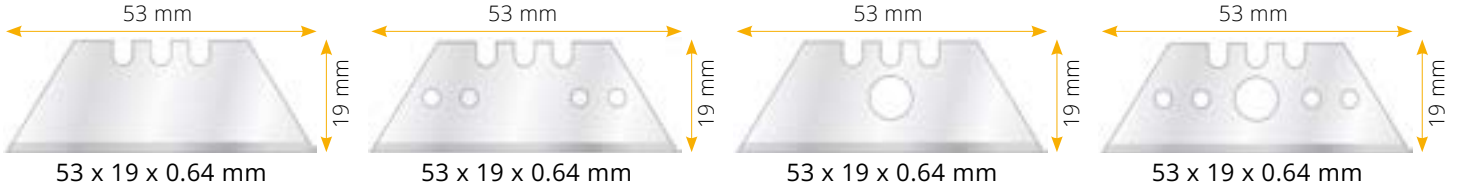

Standart Tip / Standard Type

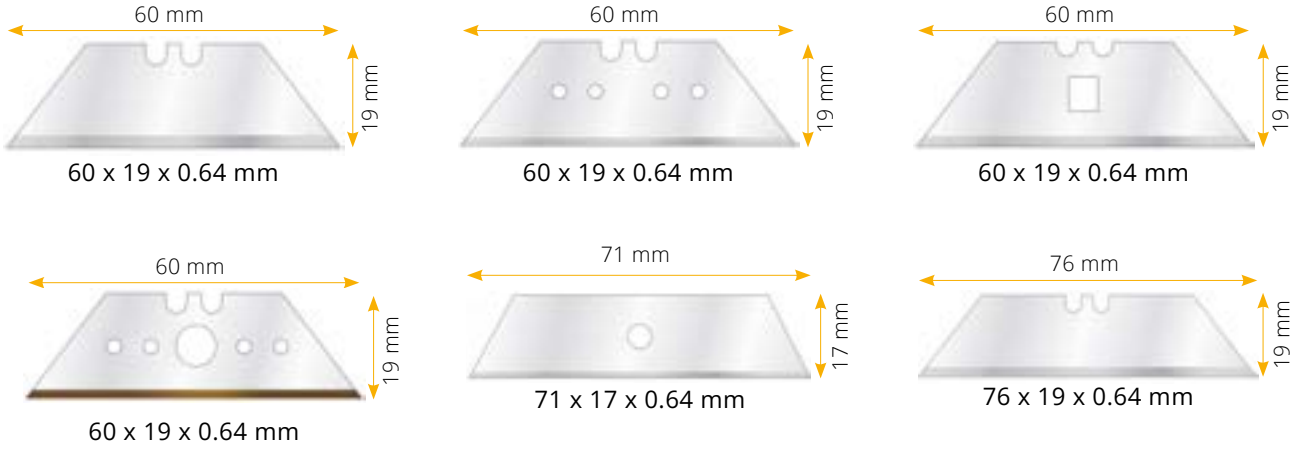

Duvar Kazıma Jiletler
Wall Scrapper Blades

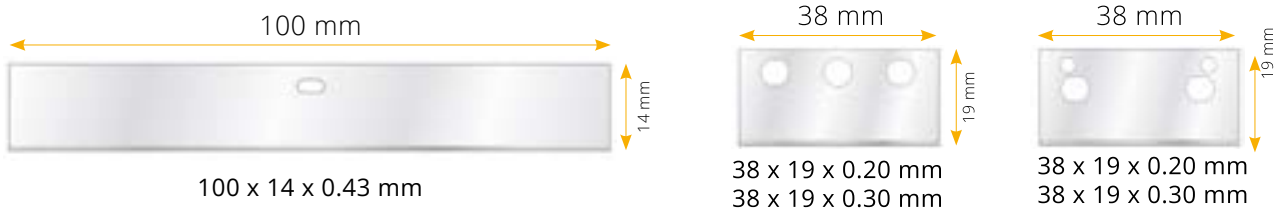

Karbür Warex Jiletler
Carbide Warex Razor Blades

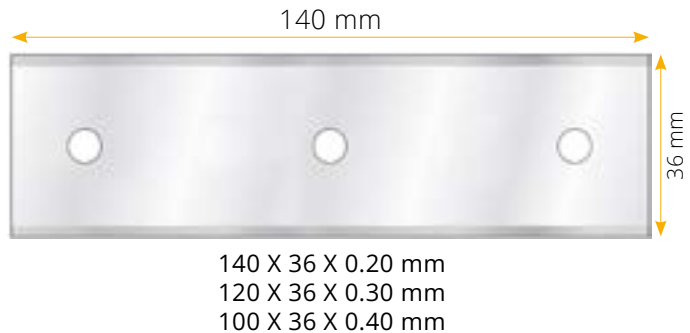

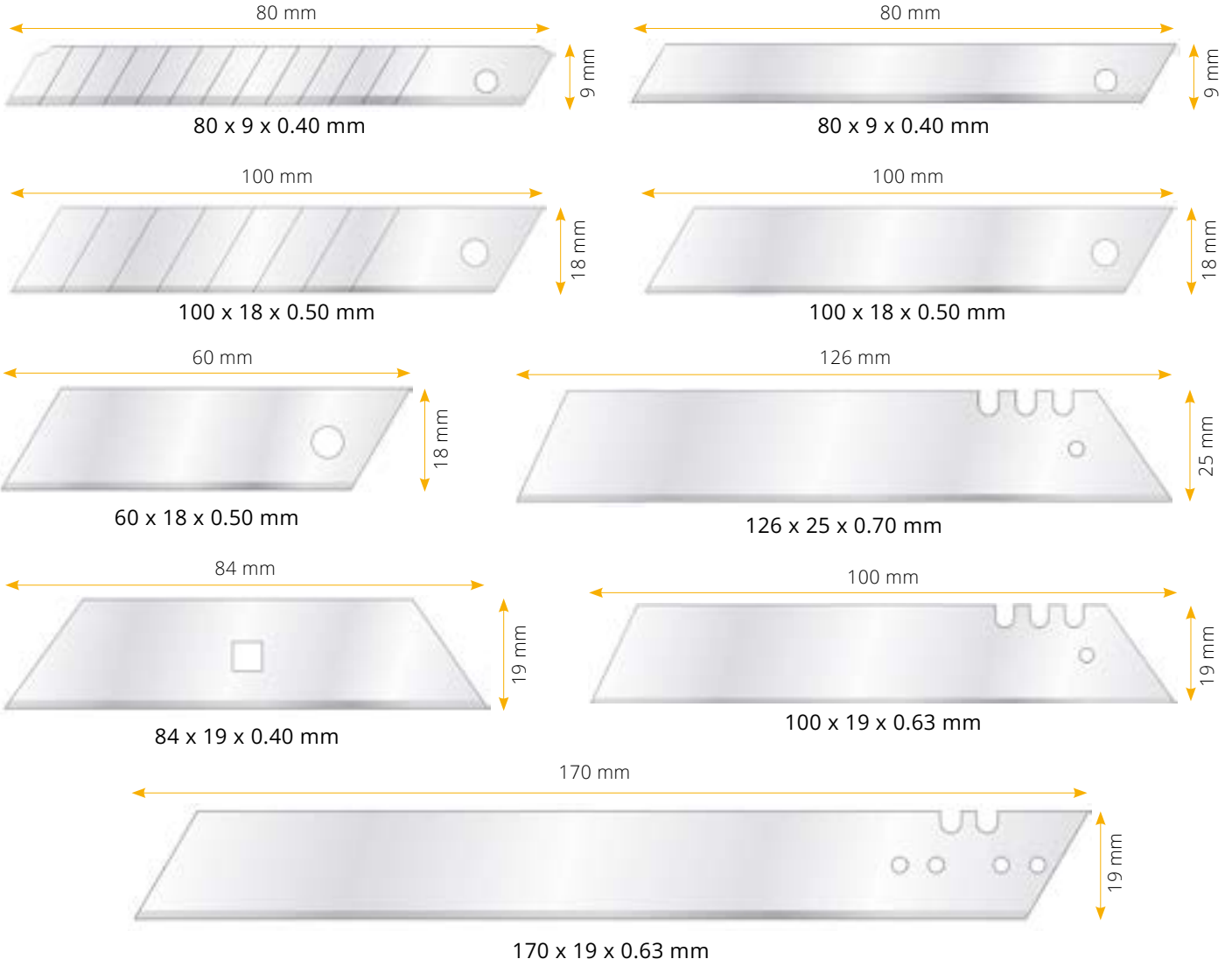

Beşgen Jiletler

Pentagon Blades

Dairesel Jiletler

Circular Blades

Üçgen Jilet

Triangle Blades

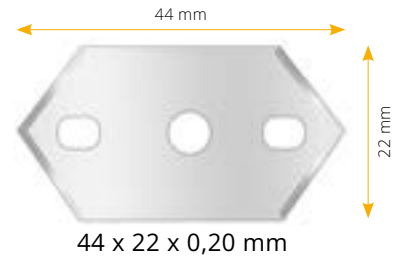

Kalınlık / Thickness

66 x 63 x 0.53 mm
Tungsten / Carbide
Seramik / Full Ceramic

Kalınlık / Thickness

28 x 8 x 0.30 mm
45 x 8 x 0.30 mm
60 x 8 x 0.30 mm
Tungsten / Carbide
Seramik / Full Ceramic

Kalınlık / Thickness

44 x 22 x 0.20 mm
Tungsten / Carbide
Seramik / Full Ceramic



KUHL®

MESSER

INDUSTRIAL BLADES

SANAYİ JİLETLERİ

Kühl Messer



www.kuhlmesser.com

Kühl Messer TÜRKİYE
İncilipınar Mah. Muammer Aksoy Blv Sever İş Mrk.
Kat 4 No: 403 Şehitkamil / GAZİANTEP

İLETİŞİM
+90 545 227 15 15
turkey@kuhlmesser.com